

MDSM-7 Installation Guidebook



CONTENTS

1	General Information	5
2	Product	6
2.1	Specification	6
2.2	Product components	6
2.3	Parts description	7
2.3.1	Main Unit	7
2.3.2	Dip Switch Description	7
2.3.3	MFB (Multi-function button) Description	8
2.3.4	LED Description	8
2.3.5	Power cable/3P	10
2.3.6	Peripheral Component Interconnect Box (PCI Box)	10
2.3.7	Vibration unit (Optional).....	10
2.3.8	Video Out Cable (Optional)	11
2.3.9	FMS Cable (Optional).....	11
2.3.10	Contactless CAN Reader(Optional).....	11
2.3.11	Ethernet cable(Optional)	11
2.3.12	Micro SD Card (Consumable).....	11
2.4	Micro 5 pin USB Cable (Optional for Calibration).....	12
3	Installation.....	13
3.1	System Connection	13
3.2	MDSM-7 installation position	14
4	PC Calibration	15
4.1	Driver Setup (ONLY SUPPORTS WINDOWS OS)	15
4.2	Calibration Setup	15
4.2.1	Access MDSM-7 Calibration page via PC.....	15
4.2.2	Calibration.....	15
4.2.3	DSM Setup	18

4.2.4	DVR Setup	19
4.2.5	Miscellaneous Settings.....	20
4.2.6	Calibration Complete.....	20
4.3	System Initialization	21
4.4	Firmware Update.....	21
4.5	Driver Registration (Face ID set up).....	22
4.5.1	Edit the driver ID	23
4.6	Ethernet Setting.....	23
4.7	Onvif Setting	24
5	Recognize MDSM-7 in computer (Install RNDIS Driver).....	24
5.1	Computer with Windows XP, 7, 8, 8.1	24
5.2	Computer with Windows 10	24

Version

No	Version	Date	Contents	Written	Note
1	1.0.0	19.07.17	Initial Release	Kevin	
2	1.0.1	19.08.22	Calibration pages modification	Kevin	
3	1.0.2	19.09.18	Face ID setting modification	Kevin	
4	1.0.3	19.09.19	Update the expression, pictures etc.	Kevin	
5	1.0.4	19.11.01	Include the error code / Onvif settings	Dominic	
6	1.0.6	19.11.22	Camera setting updates	Dominic	
7	1.0.7	19.12.16	MFB, Error Code	Julia	
8	1.0.8	20.02.10	Calibration, driver registration, etc.	Julia	
9	1.0.9	20.02.19	Changed the orders and added comment	Dominic	
10	1.1.0	20.03.10	Amendment based on firmware version 0.2.36 (snapshot, activation speed, etc.)	Jeff	
11	1.1.1	20.03.26	Update the face ID information	Dominic	

1 General Information

MDSM-7 installation requires wiring electric lines from vehicles. Please contact your local distributor or authorized installers for installation. MOVON will hold no liability of any damage occurred during installation proceeded by users, or unauthorized installers.









MDSM-7 is developed to give only warnings to drivers. The final decision to maneuver or control shall be made by drivers themselves. Furthermore, MDSM-7 is not capable of providing 100% detection rate. Please ensure that keep eyes forward while driving rather than only relying on MDSM-7.

2 Product

2.1 Specification

Item		Description
Main Processor		ARM Cortex A7 Quad
Sub Processor		ARM Cortex M0 (for illuminator & Camera Control)
Camera	Effective Pixels	720 X 480
	View Angle	42°(D) 30°(H) 29°(V)
Video	Video Out	CVBS 1Vp-p 75Ω
Operating Temperature		-20~70°C
Storage Temperature		-40~85°C

2.2 Product components

Main unit	Power cable 3P	PCI Box	Hexagon wrench 4 x Screws	
				
Micro SD card (Consumable)	Contactless CAN Reader (Optional)	FMS Cable (RS-232) (Optional)	Vibration unit (Optional)	Ethernet cable (Optional)
				

2.3 Parts description

2.3.1 Main Unit



2.3.2 Dip Switch Description

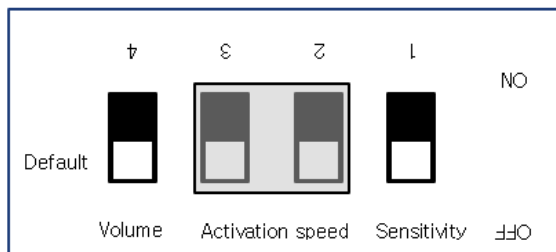

Settings	Switch	Description	
Sensitivity	1	On: Level 3 Off: Level 2(Default)	
Operating speed	2-3	OFF – OFF (Default)	OFF - ON 40kmh / 25mph
		ON - OFF 20kmh / 15mph	ON - ON Test mode
Volume	4	ON: Level 4 OFF: Level 2(Default)	
	MFB	Press the button → Volume changes in a loop (Current volume → .. → 2 → 3 → 4 → 1 → 2 →,..)	

2.3.3 MFB (Multi-function button) Description

① Camera angle settings (External screen is required)









Press the button until you get 5 beeps. Then, you will enter camera angle setting mode. Check the screen, if your face is placed within the large square, both LED1 and LED2 are off and stay for 3 seconds. Then LED1 turns to green and it will reboot automatically and apply new angle settings.

② Volume settings

Click the button once to increase the volume. Each click increases 1 volume level. It starts from current volume and changes in a loop from 1 to 4. After volume 4, it goes to level 1. (Current volume.. -> 3 -> 4 -> 1 ->2 ->3 ->...).

2.3.4 LED Description

① Warning status alarm

Features	Features	Level (Seconds)			LED 2 (Blinking)
		3	2	1	
Drowsiness	When the driver closes eyes for certain period	1.5	2	2.5	
	If the driver closes eyes again within 30 seconds	-			 & 
Distraction	When the driver looks outside of warning range below	3	4	5	
	If the driver remains distracted for certain period	5	6	7	 & 
Yawning	When the driver yawns for 3 seconds twice within 1 minute	3			
Phone use	When the driver talks over the phone for certain period (Every 30 seconds)	2	3	4	
Smoking	When the driver smokes for certain period				

② Parameters of warnings

Type of warning	Level 3		Level 2 (Default)		Level 1	
	Time	Angle	Time	Angle	Time	Angle
Drowsiness	1.5S	Left : 25° Right : 25° Top : None Down : 15°	2S	Left : 30° Right : 30° Top : None Down : 20°	2.5S	Left : 35° Right : 35° Top : None Down : 25°
Distraction	3S		4S		5S	
	Extra warning: 5S		Extra warning: 6S		Extra warning: 7S	
Phone	2S		3S		4S	
Smoking						
Yawning	3S	3S	3S			

③ Error Status

Error Description	LED Color	Possible Cause
Camera Error	 <p>LED 1: Yellow LED 2: Red</p>	Camera component error
GPS Error	 <p>LED 1: Yellow LED 2: Blue</p>	GPS component error
Other problems	 <p>LED 1: Yellow LED 2: Green</p>	SD Card or Video recording error CAN communication error

*** RS232 output data**

: MDSM-7 transmits Error code in a RS232 output data format. Please see MDSM-7's output protocol document.

2.3.5 Power cable/3P

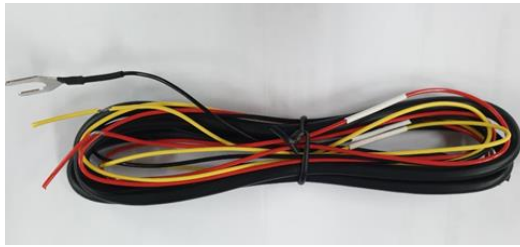

※ Power cable to the vehicle.

Color	Label	Connection Description
Red	IGN	To ignition (ACC) power line (Turns off when key is at OFF)
Yellow	Power	Battery power line
Black	GND	To ground source * Please ensure that is connected properly to ground, or it could damage the vehicle and MDSM-7.

2.3.6 Peripheral Component Interconnect Box (PCI Box)

Peripheral Component Interconnect Box (PCI Box) is to connect the cables and accessories.



PCI BOX LED status table	
Color	status
Yellow	In case of wiring only constant power
Green	In case of wiring constant power and IGN power

2.3.7 Vibration unit (Optional)

* NOTE: Vibrator gender cable is necessary and also this function needs to be enabled during calibration process.



2.3.8 Video Out Cable (Optional)

Video out cable is to transmit analog video to another device using RCA connector.



2.3.9 FMS Cable (Optional)

FMS cable is to transmit DSM event data to another FMS (Fleet Management System) through RS-232.



2.3.10 Contactless CAN Reader(Optional)



2.3.11 Ethernet cable(Optional)

: Transmit the video through Ethernet Port. (RJ45)



2.3.12 Micro SD Card (Consumable)

* Micro SD card is consumable product. Only first 3 months will be guaranteed. It is recommended to format micro SD card regularly and replace it when it cannot be recognized in MDAS.

**** Micro SD card speed shall be above Class 10 and it is recommended to use MLC type.**



File size	SD card storage	Max. Recording time(Normal mode)
20Mb	16G	Approx. 7 hours 20 minutes
	32G	Approx. 14 hours 40 minutes

*** Caution**

Depending on your environment, actual recording duration and SD card lifespan may vary. For stable performance, it is recommended that you format the memory card every 2-3 weeks. Formatting will delete all data in the card. If you want to keep the data, please back up in advance. If MDAS fails to format the card more than twice, please try formatting using PC. It may happen to some SD cards. When you extract the card, please

2.4 Micro 5 pin USB Cable (Optional for Calibration)

* NOTE: You can use a common USB cable that supports data transmission.

For calibration with **Windows OS** computers. Before the calibration, please install RNDIS driver, first. (See Chapter 4.1)



3 Installation

3.1 System Connection



- ① Place MDSM-7 on the dashboard (refer to chapter 3.2)
- ② Connect Main cable to the PCI box.
- ③ Connect the power cable to PCI box and vehicle.

Power cable to the vehicle.

Color	Label	Connection Description
Red	IGN	To ignition (ACC) power line (Turns off when key is at OFF)
Yellow	Power	Battery power line
Black	GND	To ground source * Please ensure that is connected properly to ground, or it could damage the vehicle and MDSM-7.

* There are different ignition powers, it is recommended to use an ignition power (IG1) that does not drop power shortly when the engine turns on

- ④ After installation, do calibrate referring to Chapter 4.

3.2 MDSM-7 installation position

FRONT VIEW

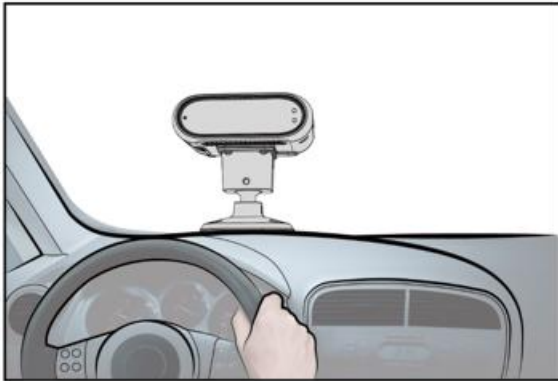

SIDE VIEW

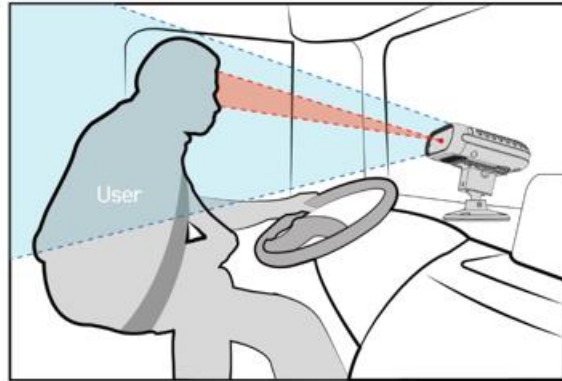

- ① Please **place MDSM-7 in front of the driver** for the best performance.
- ② Distance should be **80-100cm from the eyes of the driver to MDSM-7 camera**.
- ③ If MDSM-7 cannot be located in the center, it is recommend to locate within right and left side 15°.
- ④ Please make sure the **camera should be lower than driver's eyes level**, about 15-30°
- ⑤ The camera should face the driver's face directly and MDSM-7 should be fixed with 4pcs screws.
- ⑥ After fixing cradle, installer has to adjust the camera pitch angle.
- ⑦ After adjusting the camera's pitch angle, fix it using hexagon wrench.

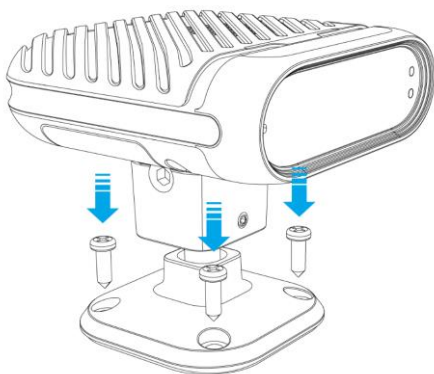

4 PC Calibration

4.1 Driver Setup (ONLY SUPPORTS WINDOWS OS)

* NOTE: Before you connect or start calibration, please install RNDIS driver first.

4.2 Calibration Setup

4.2.1 Access MDSM-7 Calibration page via PC

- ① Connect MDSM-7 to PC using Micro USB cable with 5 pins.
- ② Power on MDSM-7. If you hear repeated beep sound, this means MDSM-7 is properly connected to computer.
- ③ Activate the browser and enter into <http://20.0.0.1:18087/> to access MDSM-7 calibration page. Google Chrome is recommended.
- ④ If you see the page below, please select language you want and sign in using following information
 - **ID: admin**
 - **Password: 1234**

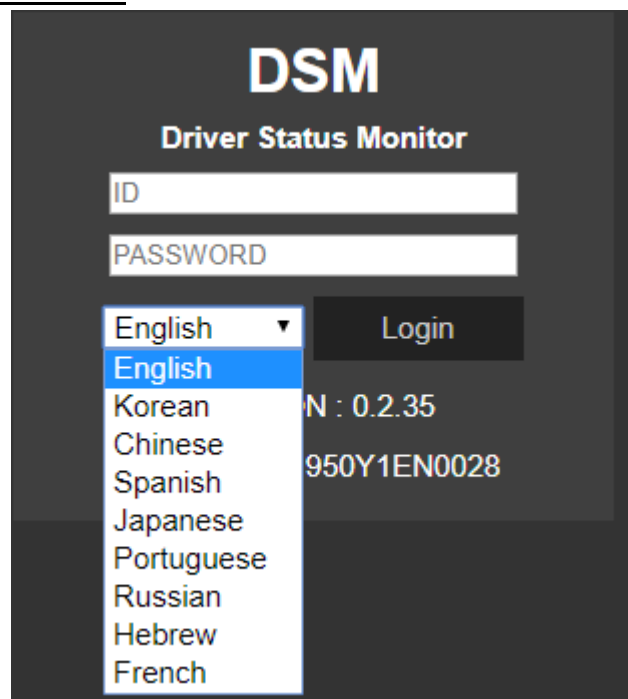

4.2.2 Calibration

4.2.2.1 Select Speed Type

- ① GPS Speed setting
GPS antenna is embedded on MDSM-7. If GPS work correctly, detected is shown. If GPS doesn't work for 5 mins, Fail is shown.

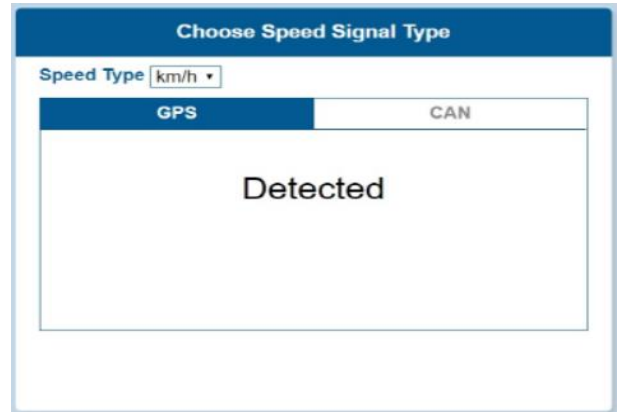
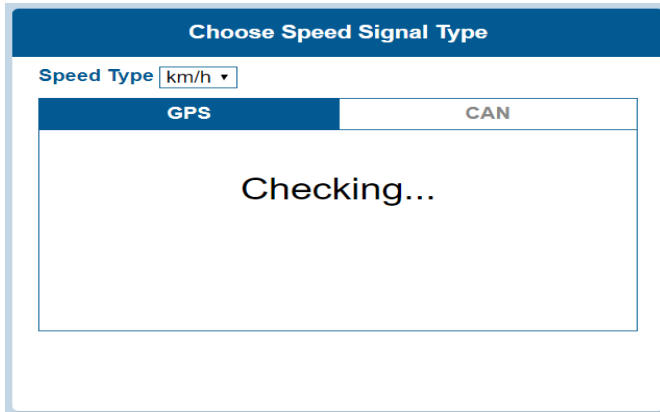

② CAN Speed setting

MDSM-7 can get speed through CAN as well.

MDSM-7 only recognizes encrypted CAN data from our Database site;
<http://info.mdas.co.kr>

Please download can file from the DB and upload to system.

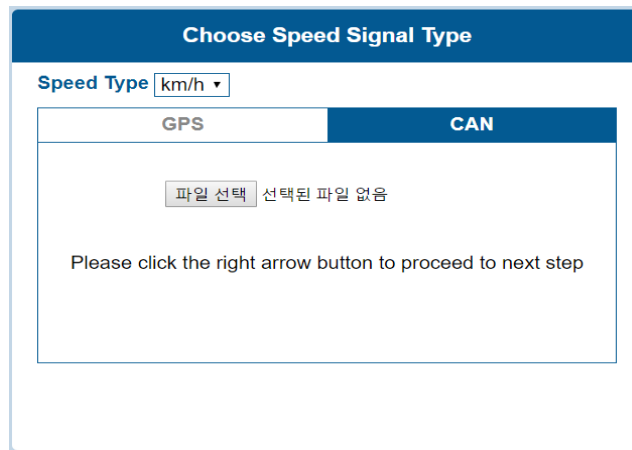

4.2.2.2 Verify Speed Signal

You can check the speed data is coming correct by test drive.

If there is a deviation, please use the following correction method.

Please click the "Correction" button when you drive at 40km/h (24mph). Then, MDSM-7 will set new speed automatically.

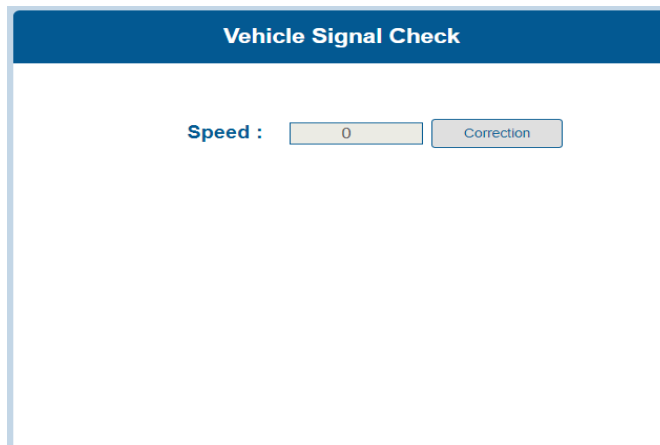

4.2.2.3 Camera Setting

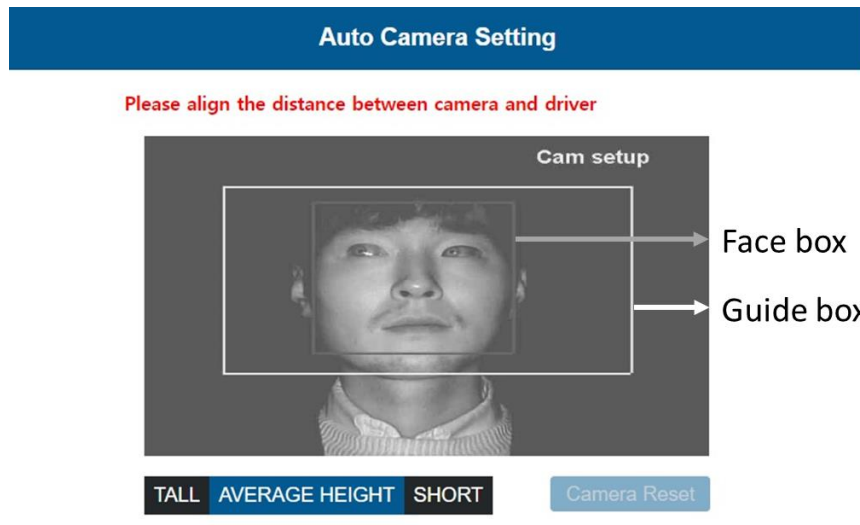

- ① Place your face inside the guide box. The face box should fit inside the guide box to proceed to next step.
- ② Wait 3 seconds to complete and save camera setting.
- ③ When the setting is complete, the page will change like below and the unit will make multiple beeps.

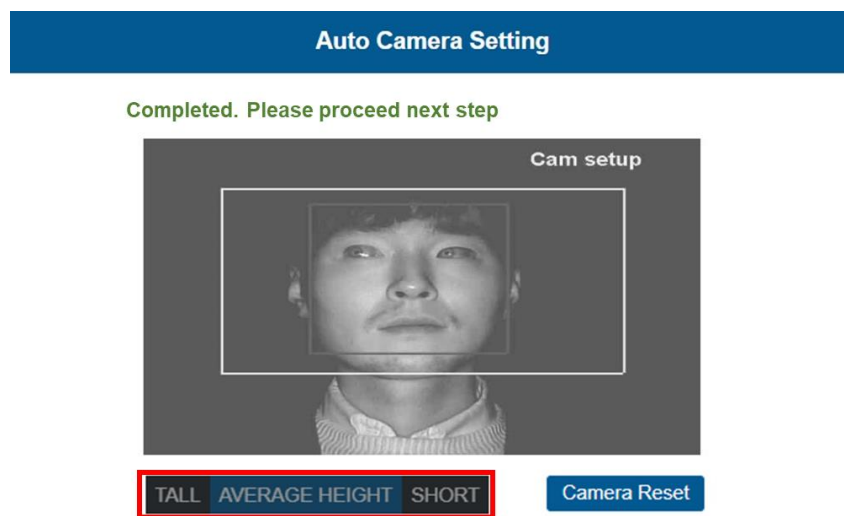

- **Height option**

If the installer/technician is relatively tall or short compared to male average height of the country, please choose “tall” or “short” option. Then, the guide box will move up or down accordingly. Please fit your face inside the adjusted guide box.

4.2.3 DSM Setup

The screenshot shows the 'DSM Setup' interface with the following settings:

	Drowsiness	Distraction	Yawning	Phone Use	Smoking
ON/OFF	ON	ON	ON	ON	ON
Warning alarm sound	1	2	1	1	1
Vibrator	ON	ON	ON	ON	ON
Sensitivity	3	3		2	2
DIP switch on unit	OFF				
Sound Level	4				
Activation speed	Others (dropdown menu open showing 0, 15, 20, 25, 30, 40, 50, 60, Others)				

- ① **ON/OFF:** Enable Drowsiness, Distraction, Phone, Smoking, Yawning.
- ② **Sound Type:** Check the warning sound and select the one you prefer.
- ③ **Vibrator:** Enable vibration function. (On / Off)
- ④ **Sensitivity:** Set the sensitivity on a scale of 1 to 3. As the level gets higher, it gets more sensitive. Yawning warning will generate when yawning for 2 seconds.
- ⑤ **DIP switch on unit:** Enable DIP switch on MDSM-7's unit.
- ⑥ **Sound Level:** Control the warning sound level on a scale of 1 to 4.
- ⑦ **Activation Speed:**
 - Set the Activation Speed (15 ~ 60Km/h ≒ 10 ~ 40mph). The functions will be activated when the vehicle is faster than this speed.
 - In **Test mode(0Km=0mph)**, the functions are activated regardless of the speed.
 - If you select Others, you can input the activation speed in the below box. Note that the input range is between 5Km and 100km.

The screenshot shows the 'DSM Setup' interface with the following settings:

	Drowsiness	Distraction	Yawning	Phone Use	Smoking
ON/OFF	ON	ON	ON	ON	ON
Warning alarm sound	1	1	1	1	1
Vibrator	ON	ON	ON	ON	ON
Sensitivity	2	2		2	2
DIP switch on unit	OFF				
Sound Level	4				
Activation speed	Others (dropdown menu open showing 0, 15, 20, 25, 30, 40, 50, 60, Others)				
	40 (input field)				

4.2.4 DVR Setup

DVR Setup

1. Time

Asia/Seoul

▼

Jan

▼

25

▼

1970

▼

10

▼

:

01

▼

← PC

2. Voice recording ON ▼

3. Gravity sensor sensitivity Level3 ▼

4. Driving log with video ON ▼

5. Record ratio(Continuous:G-Sensor:DSM) 6:1:3 ▼

- ① **Time:** Set the date and time.
Please click the ← PC button, the time information on PC is saved automatically
- ② **Voice Recording:** Enable Voice recording function (On / Off).
- ③ **Gravity sensor sensitivity:** Set the sensitivity of event recording. Scales of 1 to 5 and the higher number is more sensitive.
- ④ **Dring log with video:** Enable Driving log with video (On / Off).
- ⑤ **Record Ratio:** Set the Recording ratio (Continuous : G-sensor: DSM).
You can allocate the recording capacity of SD card from 0:0:10 ~ 10:0:0.

Mode	Description	File name	Folder
Continuous	Record continuously. Create file every 1 miute in a loop	Date_Time (20190601_063903_NOR)	NOR
G-sensor	Record when G-sensor detect events for 30 seconds.	Date_Time (20190601_063903_EVT)	EVT
DSM	Record when DSM events detected for 30 seconds	Date_Time_DSM event type (20190601_063903_DSM)	DSM

4.2.5 Miscellaneous Settings.

Miscellaneous Settings

1. FMS RS232 Baudrate	9600 ▾
2. Video Out Format	NTSC ▾
2-1. Information Display	OFF ▾
3. K-Line Baudrate	9600 ▾
4. Repeat alarm when camera covered	ON ▾
5. Snapshot Transmission	OFF ▾

- ① Set the baudrate to transmit data through RS-232 (Off/ 9,600/19,200/57,600/115,200)
- ② Set Video out format (NTSC / PAL)
2-1: Choose if you want to display the dots on display
- ③ Set the K-Line Baudrate (Off/ 9,600/19,200/57,600/115,200)
- ④ Repeat alarm when camera covered
 - if it is ON, alarming sound is generated every 3 minutes.
- ⑤ Snapshot transmission
 - If it is ON, snapshot is transmitted out when drowsiness alert is occurred.

4.2.6 Calibration Complete

Calibration Complete

Please press the button to complete calibration

Complete

Press the button to export all settings

Export All Settings

- ① Click “Complete” button to finish Calibration setup. Then MDSM-7 will be rebooted automatically.

- ② Click “Export All Settings” button, if you want to download vehicleprofile.dat. This vehicleprofile contains all the calibration settings you’ve set. With this file, you can simply apply current settings to another vehicle.

*** How to use ‘vehicleprofile’ for MDSM-7.**

- A. Copy and paste vehicleprofile.dat into the micro SD card, formatted by MDSM-7. Otherwise, MDSM-7 will automatically format the SD card.
- B. Insert the micro SD card into MDSM-7 which you want to apply the exported profile.
- C. MDSM-7 will be rebooted automatically. Then, the profile will be applied to MDSM-7.

4.3 System Initialization

If you want to delete all data and return to factory setting, click the “System Initialization” on the menu.

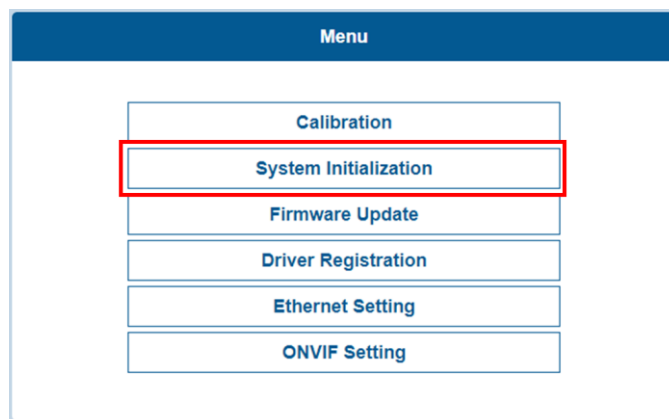

4.4 Firmware Update

- ① Select “Firmware Update” to upload the latest firmware.

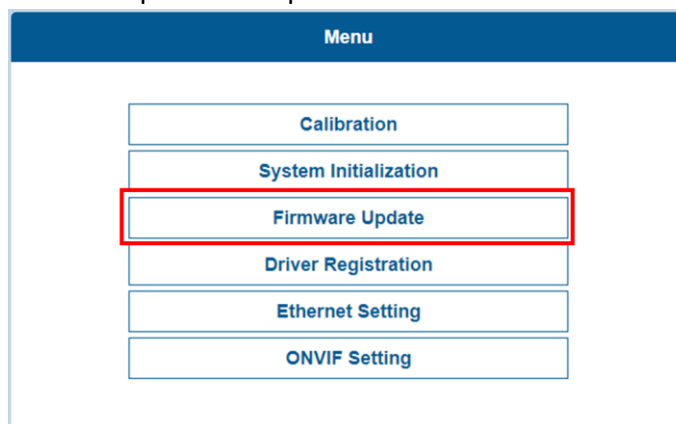

- ② After uploading the file, click “Update Firmware” button below. Then, MDSM-7 will automatically reboot.

4.5 Driver Registration (Face ID set up)

- ① Please look at the camera and click the “Add “button to register driver ID.



- ② Registered driver IDs will be listed on the right side. Click the ID to change the name as you want.

* Max 10 characters in Alphabet & Underbar only

* Maximum 20 ID can be stored

* If you register more than 20 IDs, then the first ID (on the top) will be replaced





- ③ Once you finish the ID registration. Please click the Save button. 



- ④ Please click the Exit button to exit and reboot . Please be noted that any unsaved changes cannot be restored.

4.5.1 Edit the driver ID

① **With PC (Single data)**

-  Load the driver ID file from your computer
-  Save the driver ID file on your computer
-  Delete the driver ID file

② **With SD card (As a group)**

-  **Download** All registered data will be saved/downloaded on the SD card as a group
-  **Upload** Load/upload the driver IDs from the SD card as a group

③ When you finish editing, please click **"Save"** and **"Exit"**.

4.6 Ethernet Setting

Network

DHCP	<input type="checkbox"/>
IP Address	<input type="text" value="10.0.0.88"/>
Netmask	<input type="text" value="255.255.255.0"/>
Gateway	<input type="text" value="211.168.69.1"/>

FMS Enable	<input type="checkbox"/>
IP Address	<input type="text" value="10.0.0.88"/>
Port	<input type="text" value="8888"/>

① IP address : Please type the MDVR's IP address on IPv4 IP address. The last three digit needs to be different with MDVR's IP address. Refer to the below table

MDVR's IP address	MDAS-9NPlus's IP address
10.0.0. 10	10.0.0.88. xxx (except 10)

- ② Netmask : type the MDVR's netmask address on the IPv4 address.
- ③ Gateway : type the MDVR's gateway address on the IPv4 address.
- ④ Assigned by DHCP(Dynamic Host Configuration Protocol) Sever
In case DHCP is enable, the IP address can be assigned automatically.
- ⑤ Assigned manually

Type the DNS server IP address, which should be provided by your ISP

- ⑥ FMS enable
 - A. If FMS Enable is checked, DSM event data packet is transmitted out through Ethernet cable.
 - B. Please input your MDVR's IPv4 address on IP address blank.
 - C. Port digit 8888 could be changed according to MDVR's requirement.

4.7 Onvif Setting

This page is designed only for an engineer who fully understands Onvif protocol. If port number and address of Onvif setting need to be changed, please contact a manufacturer or distributor.

ONVIF Setting

NIC:	<input type="text" value="eth0"/>
ONVIF port:	<input type="text" value="8080"/>
RTSP port:	<input type="text" value="8554"/>
RTSP URI:	<input type="text" value="user=admin_password=tLjwpbo6_chann"/>
Manufacturer:	<input type="text" value="movon corp"/>
Model:	<input type="text" value="MDSM-7"/>
Scope Name:	<input type="text" value="NVT"/>
Scope Location:	<input type="text" value="country/korea"/>

Complete

5 Recognize MDSM-7 in computer (Install RNDIS Driver)

* Please connect MDSM-7 to your laptop using Micro 5Pin USB cable before install the driver. *

5.1 Computer with Windows XP, 7, 8, 8.1

Download RNDIS installer here: <http://movon.co.kr/downloads/rndissetup.zip>

Please download and unzip it. When you install it, please click the right button on your mouse and select "Run as administrator".

5.2 Computer with Windows 10

- ① Download RNDIS Driver here: <http://movon.co.kr/downloads/rndisdriver.zip>
- ② Unzip the file and remember the unzipped folder location.
- ③ Go to the Device manager and select **a USB serial Port (COM x)** under **Ports (COM & LPT)**.

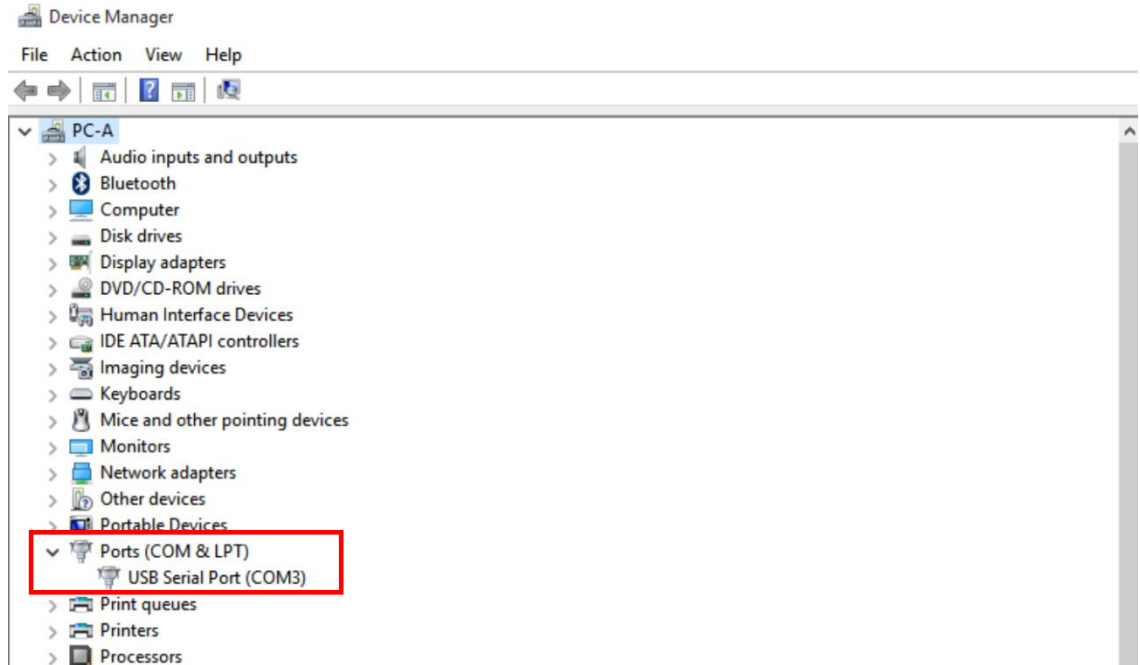

- ④ Click it using the right button of your mouse, then click "Properties".

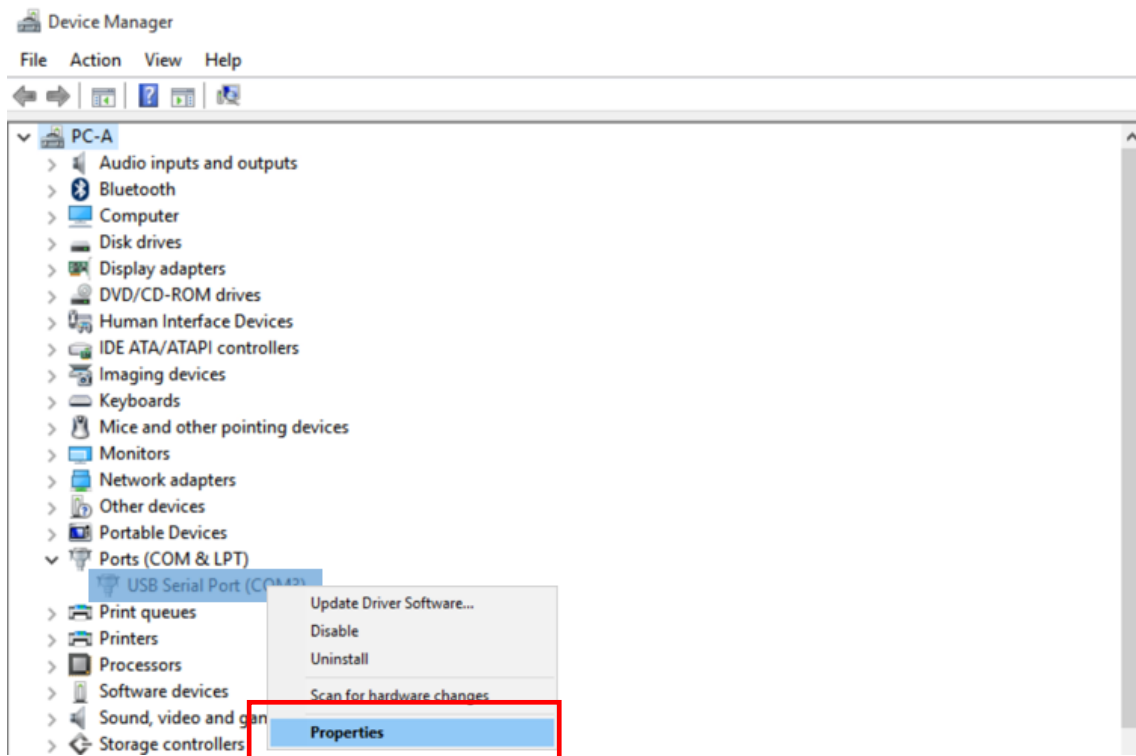

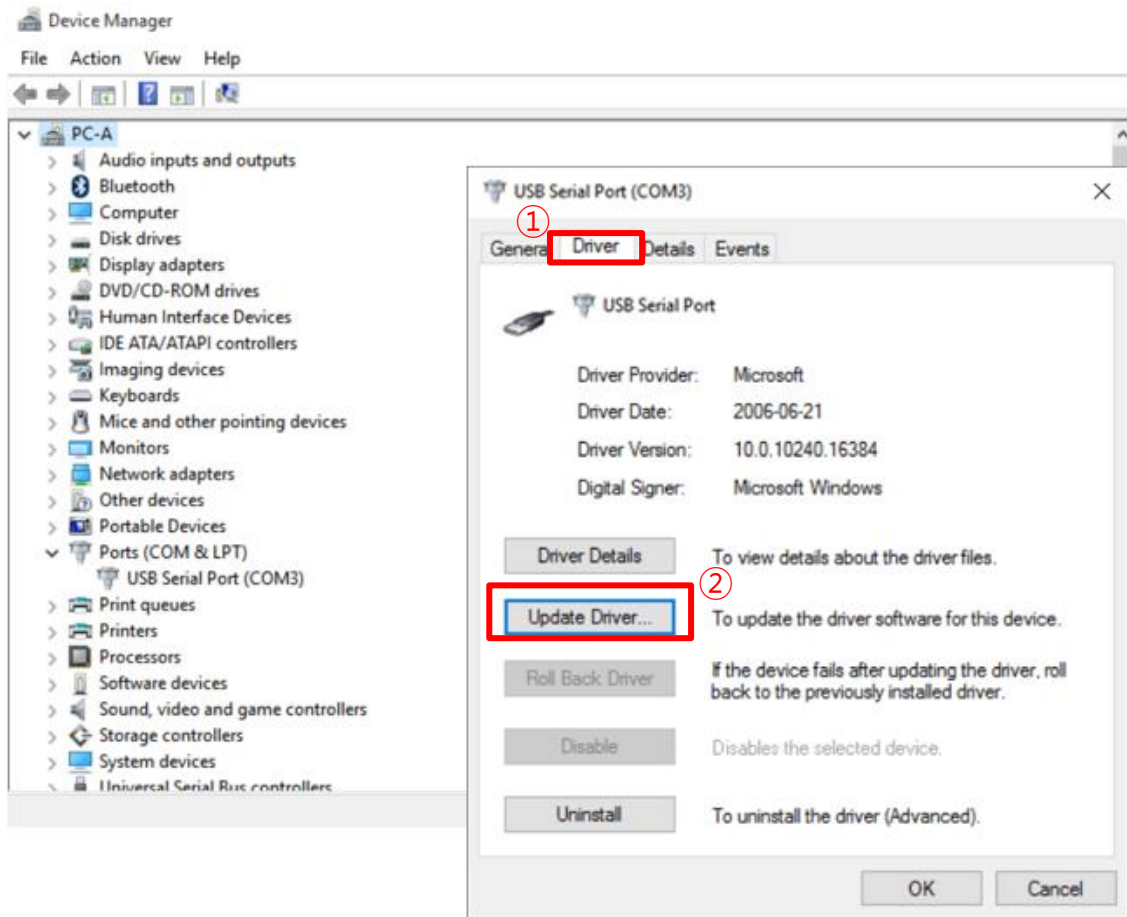

⑤ In the newly popped up window, Go to “Driver” tab, and click “Update Driver”

⑥ Select “Browse my computer for driver software”.

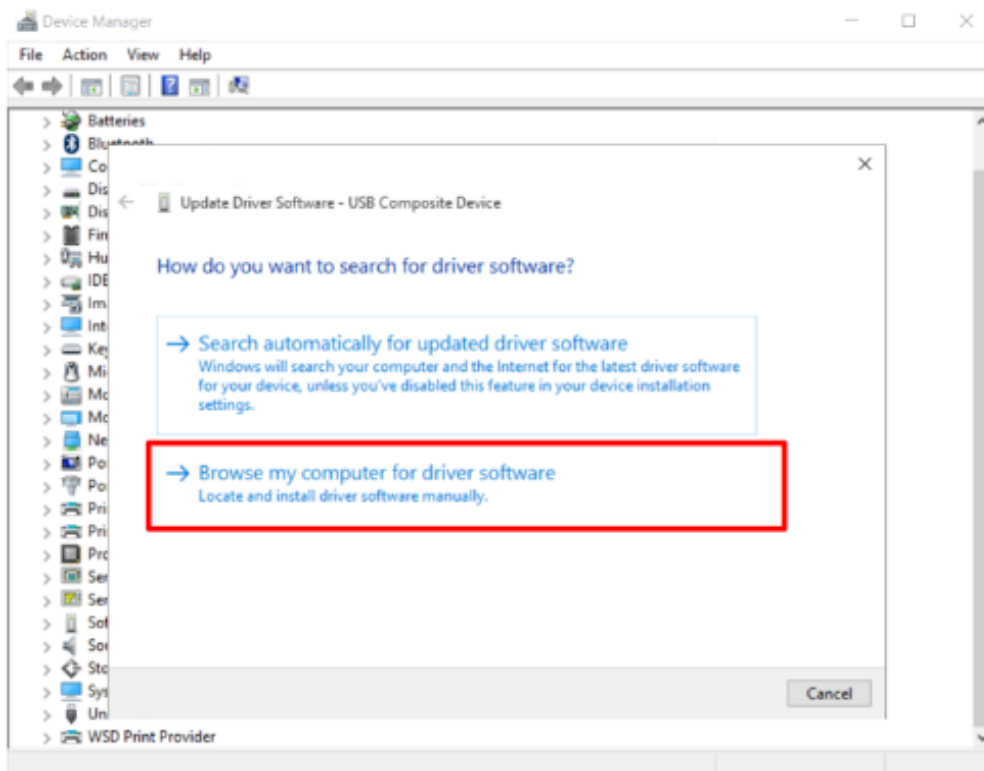

- ⑦ Click “Browser...” button and “Browse For Folder” window will pop up.

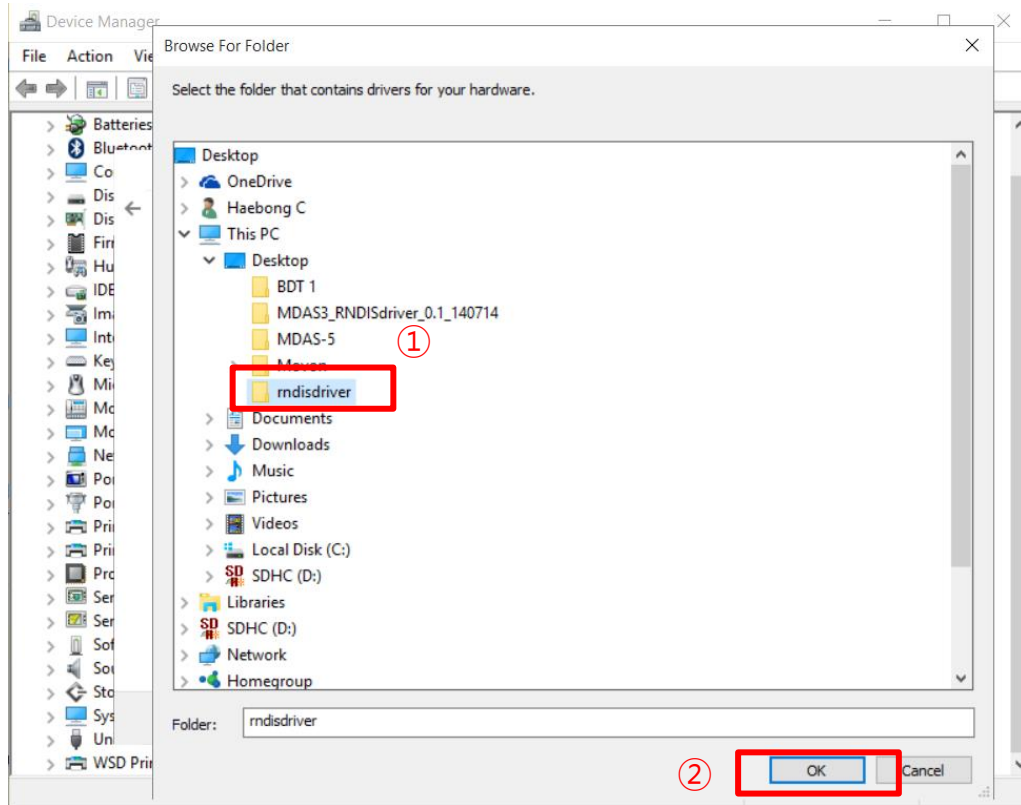

- ⑧ Choose “rndisdriver”.

* Remember the path where you downloaded and unzipped the file *

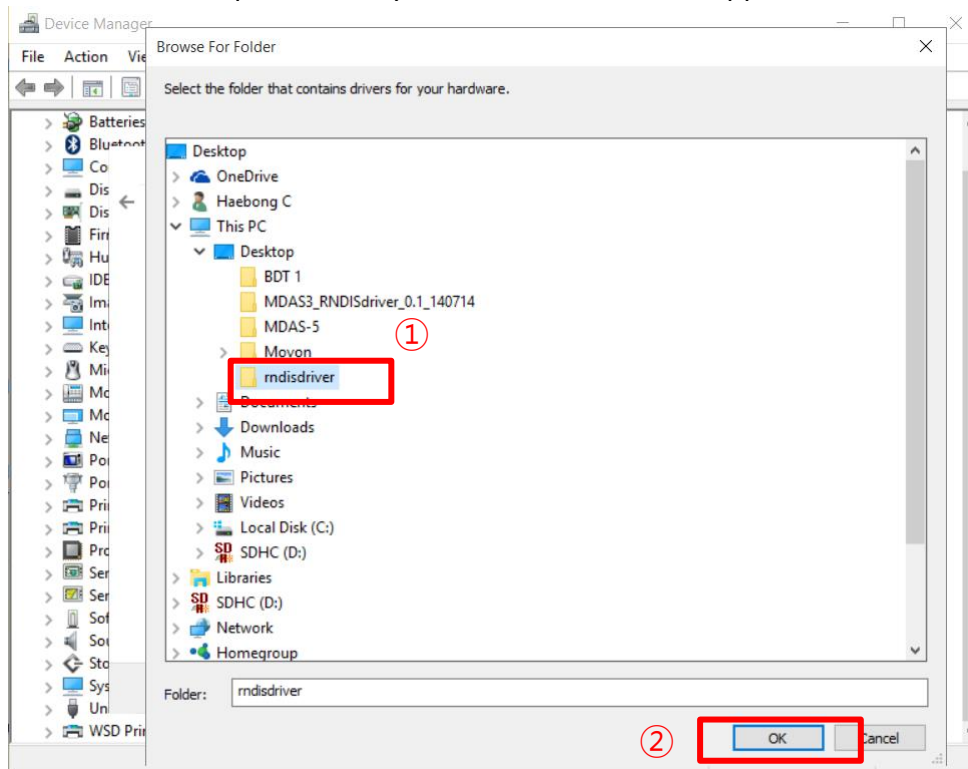

- ⑨ Press “Next” on the page below.

